

Anycubic Photon Mono X **6Ks**

6K and 9-inch Upgrade

9.1 inch 6K Screen | 4.76L Build Volume | Upgraded LighTurbo Matrix



9.1 inch 6K Large Screen

A High-resolution Experience



5760*3600
High Resolution

Larger Printing Volume

195.84x122.4x200mm (LWH)



Upgraded LightTurbo Matrix Light Source

Effectively reduces optical
layer patterns and grid lines



Large Screen Anti-scratch Protector

1 Pcs extra included



Stability and Precise Dual-linear Rail

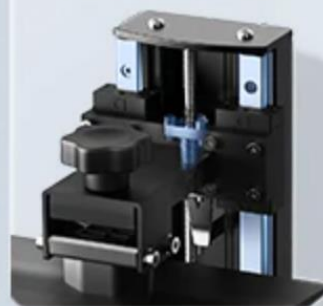

Laser-engraved Aluminum Printing Platform

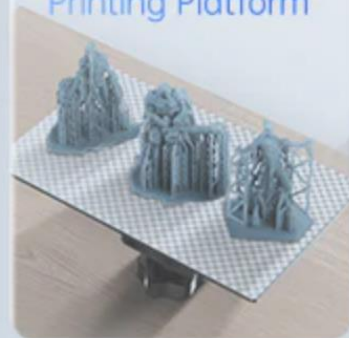

Anycubic Photon Workshop 3.0 Free Slicer

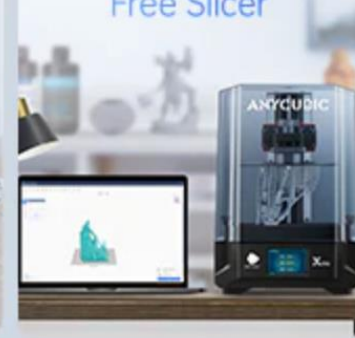

Advanced and Precise



9.1 inch
LCD Exposure Screen

6K
High-definition Pixels

5760*3600
High Resolution

380:1
Contrast Ratio

6K



Resolution Accuracy:0.03mm

4K



Resolution Accuracy:0.05mm

One free

Extra piece screen protector.



*Based on the test results of Anycubic., for reference only.



Large Printing Volume
for Larger Models



Large Printing Size
for Printing Efficiency



Sharp and Delicate Details

Light uniformity $\geq 90\%$

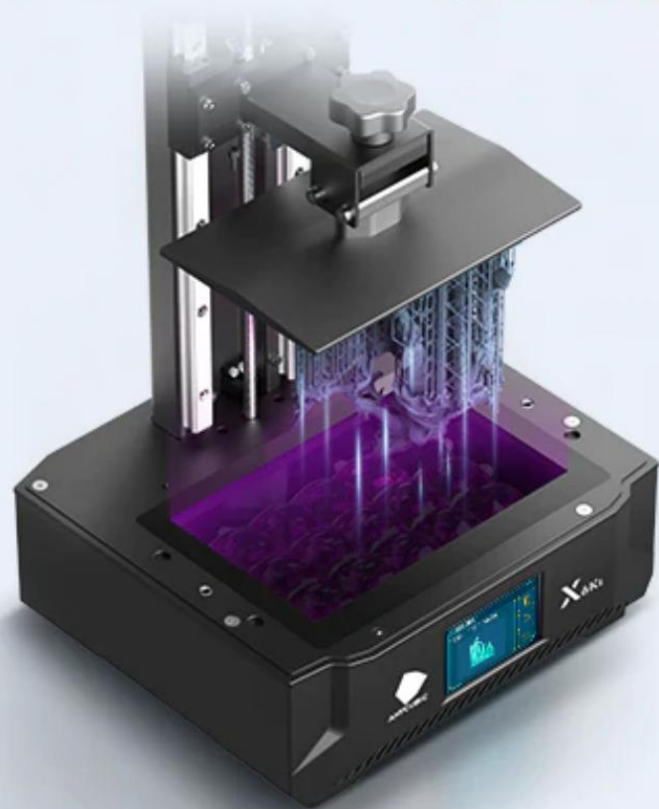

No grid lines



Upgraded Anycubic LightTurbo
matrix light source

Grid lines

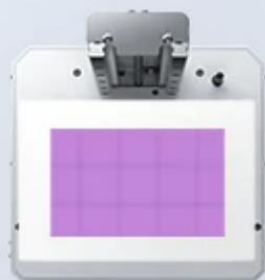

Other light sources

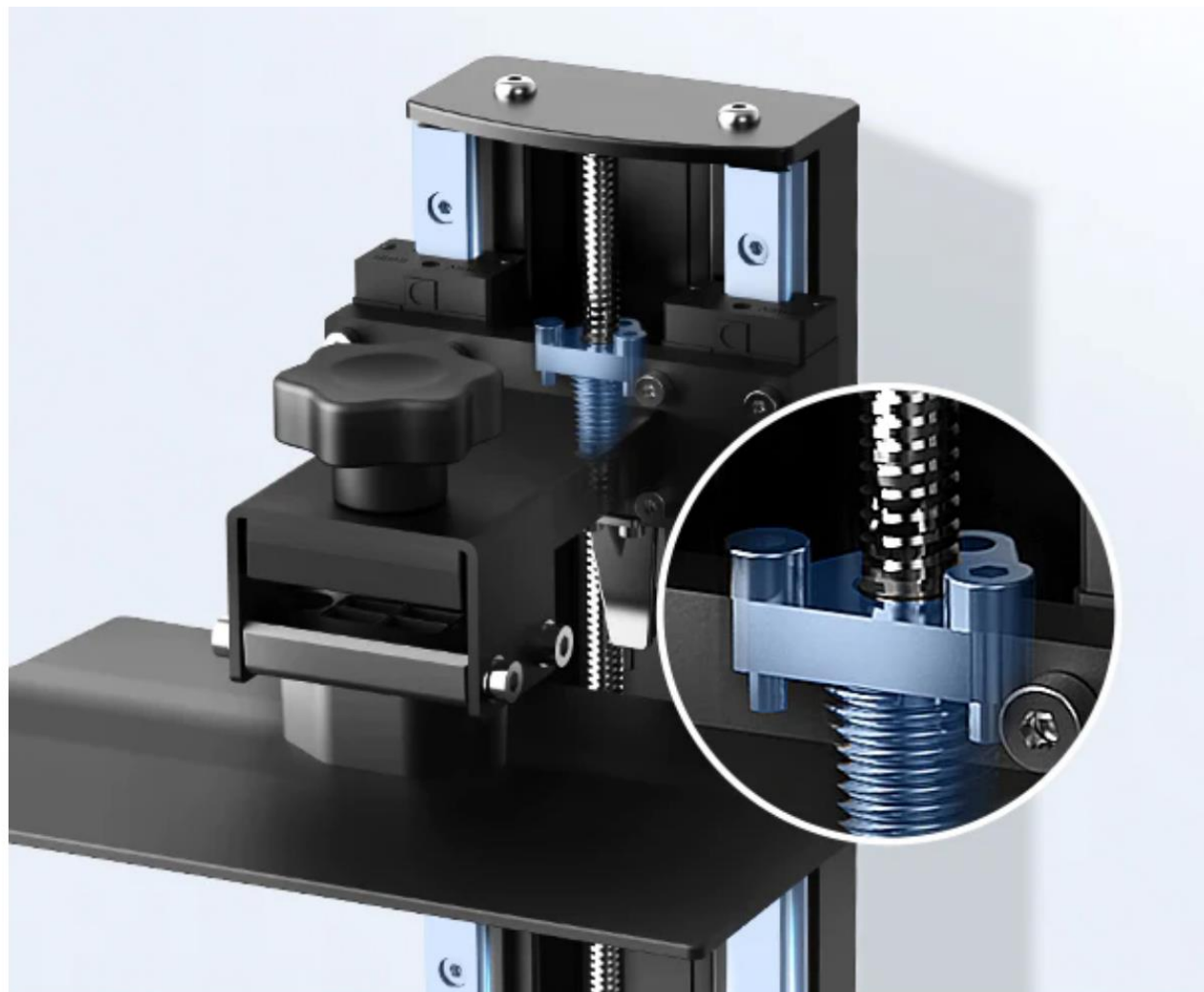

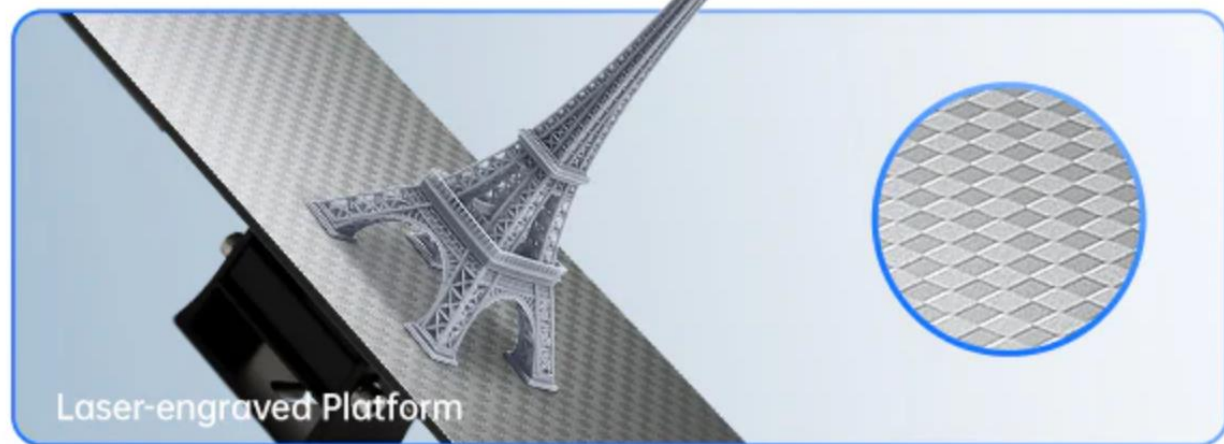
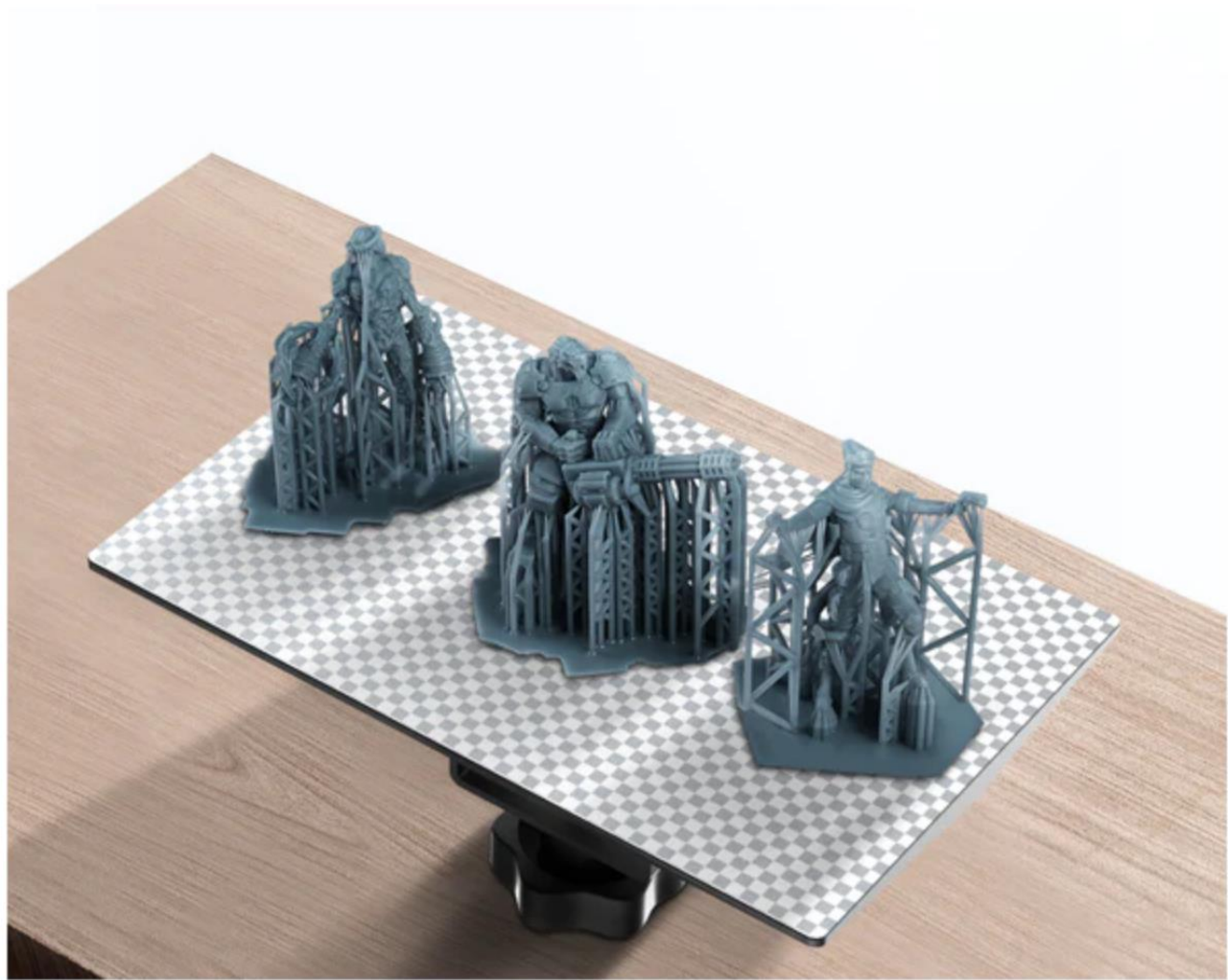

*Based on the test results of Anycubic lab., for reference only.



Anycubic Photon Workshop 3.0

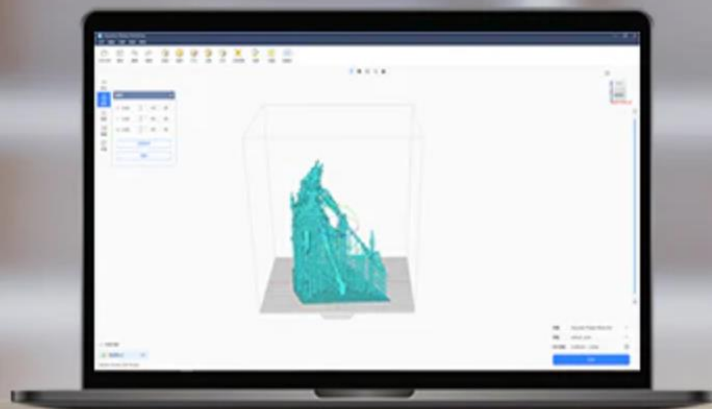



*Models printed by Anycubic Photon Mono X 6Ks.



*Models printed by Anycubic Photon Mono X 6Ks.



*Models printed by Anycubic Photon Mono X 6Ks.

Anycubic Photon Mono X 6Ks

Tech Specs

Machine Weight	8.5kg/18.7lb.	Machine Dimensions	417x290x260mm/ 16.4x11.4x10.2 in.(HWD)
Printing Volume	4.76L/161oz.	Printing Dimensions	200x195.84x122.4mm/ 7.8x7.7x4.8 in. (HWD)
Machine Leveling	4-point manual leveling	Printing Speed	15-60mm/h
Removable Cover	Effectively block UV radiation	Resin Tank	Unibody design with scale lines
Zaxis	Dual-linear Z-axis, 10µm precision	Printing Platform	Laser-engraved aluminum platform
Large Film Protector	Replaceable anti-scratch film	Exposure Screen	9.1" monochrome screen 6K (5,760 x 3,600 pixels) resolution 380:1 Contrast Ratio 6.5% light transmission 2,000 hours lifespan
Light Source	Upgraded Anycubic LighTurbo Matrix light source	Control Panel	3.5-inch TFT touch control
Data Input	USB Type-A 2.0	Power Supply	80W rated power
Power Button	On/off switch		

Anycubic Photon Mono X 6Ks

In The Box



Photon Mono X 6Ks



Printing Platform



Resin vat



Funnel

This paper can be used for leveling.

Leveling paper



Scraper

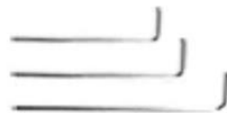

Tool Kit



Gloves



Instruction manual



Mask



Anti-scratch film kit



USB flash drive



Power adapter